



5GB, 7GB, 10GB, 18GB, 25GB, 33GB

HIGH PRESSURE MULTI-STAGE BOOSTER PUMP

FEATURES

Multi-stage Design: Provides steady, quiet, vibration free, operation.

Optional Stainless Steel Construction: Standard cast iron for general service or stainless for filtration applications.

O-Ring Casing Seal: Reliable high pressure sealing with easy disassembly for maintenance or repair.

Impellers and Diffusers: Glass filled engineered composite material with a fixed impeller design. High resistance to corrosion and abrasion.

Bowls: 300 stainless steel rabbit lock for positive alignment with no gaskets required.

Variable Capacity: Centrifugal pump design permits selection of flow within a range for each size.

Mechanical Seal: A variety of face materials and elastomers to match application needs.

Motors: Close coupled NEMA 56J motors in open drip proof or totally enclosed design. Single phase and three phase available. Ball bearings carry all radial and axial thrust loads. Designed for continuous operation.



5GB-25GB are tested to CSA-C22.2 No. 108-01.

5GBS-33GBS are CSA No. 32236914.

APPLICATIONS

- Residential, commercial or agricultural pressure wash
- Reverse osmosis
- Evaporative cooling systems/misters
- Booster service
- Spray systems
- Water circulation
- Filtration
- HVAC
- General purpose pumping

WARNINGS

- Pumps used on open spray applications must be plugged into electrical service which is protected by a Ground Fault Service Interruptor. Failure to do so may result in serious personal injury or death and property damage.
- Do not run pump dry.
- Do not run pump below minimum flow.
- If positive suction pressure is not available, be sure pump and suction line (with foot valve) are primed before starting pump.

MATERIALS OF CONSTRUCTION

Item	Description	Material
1	Motor Adapter	Cast Iron or Cast 304 Stainless Steel
2	Mechanical Seal	0=Carbon/Ceramic/BUNA 3=Carbon/Silcar/EPR 4=Carbon/Silcar/Viton
3	Shaft Coupling	Stainless Steel
4	Impeller/Diffuser	Engineered Composite
5	Bowl	304 Stainless Steel
6	Discharge Head 304 Stainless Steel	Cast Iron or Cast 304 Stainless Steel
7	Hex Shaft	Stainless Steel
8	Casing	304 Stainless Steel

SPECIFICATIONS

Pump

- Maximum suction (inlet) pressure: 75 PSI.
- Maximum Liquid Temperature: 160° F (71° C).
- Rotation: Clockwise when viewed from motor end.
- Maximum lift with foot valve: 10 ft., check NPSH curve.

Motor:

- NEMA standard 56J frame.
- Open drip proof or totally enclosed fan cooled enclosures available as standard. Consult factory for other options.
- 60 Hz, 3500 RPM. Single phase (115/230 V), three phase 208-230 (3 HP, 230 V) or three phase (208-230/460 V).
- Single phase motors have built-in capacitor and overload with automatic reset.

Note: For three phase motors, Class 20 overload protection must be provided in starter unit. Starter with overloads must be ordered separately.

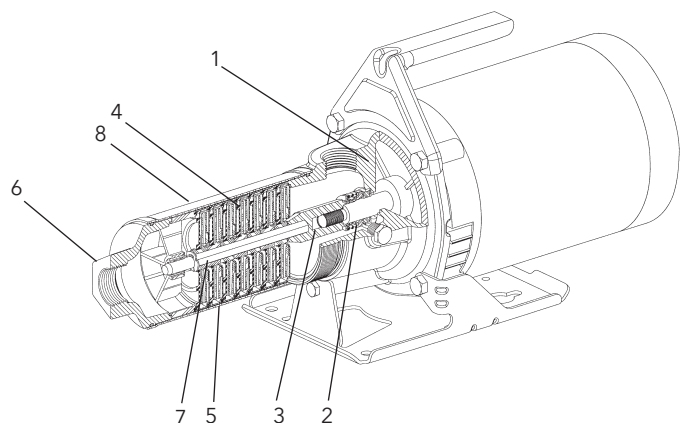

PERFORMANCE COVERAGE 60 HZ, 3500 RPM

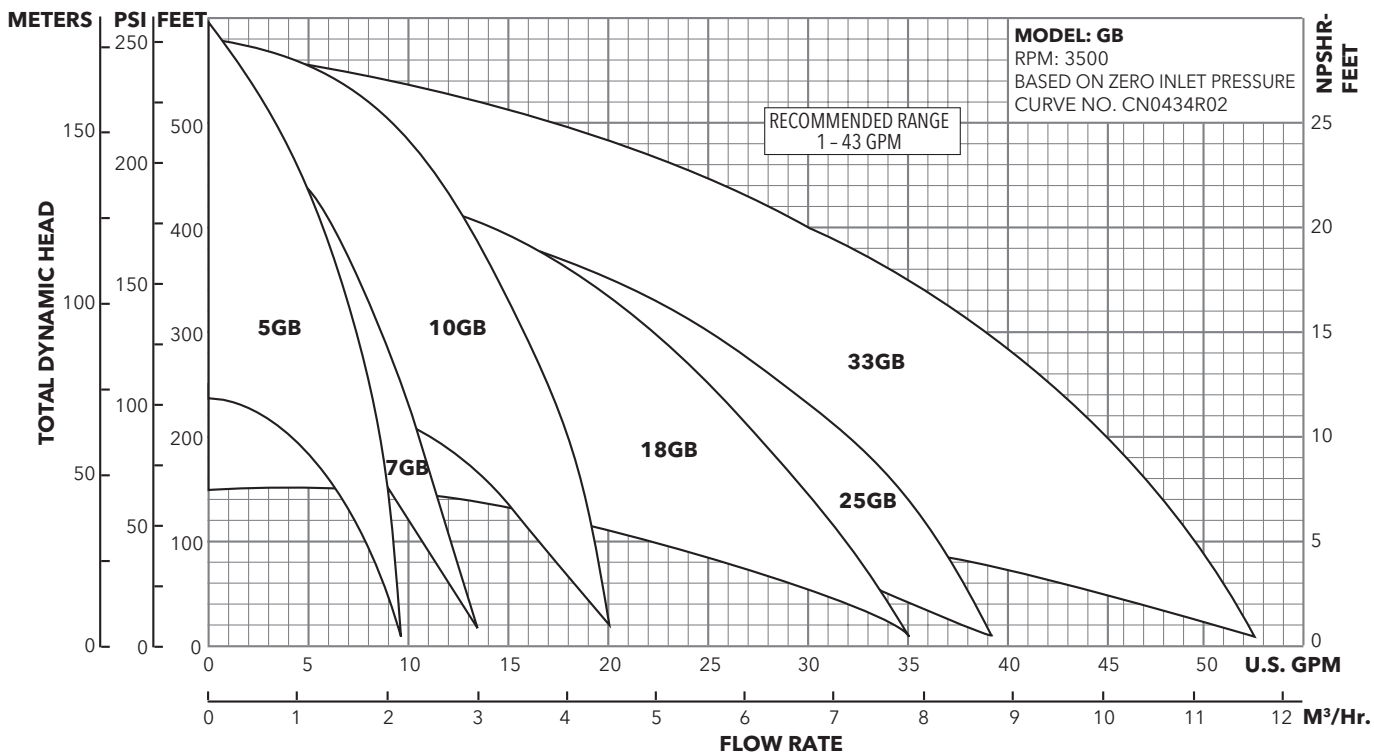

PERFORMANCE COVERAGE 50 HZ, 2900 RPM

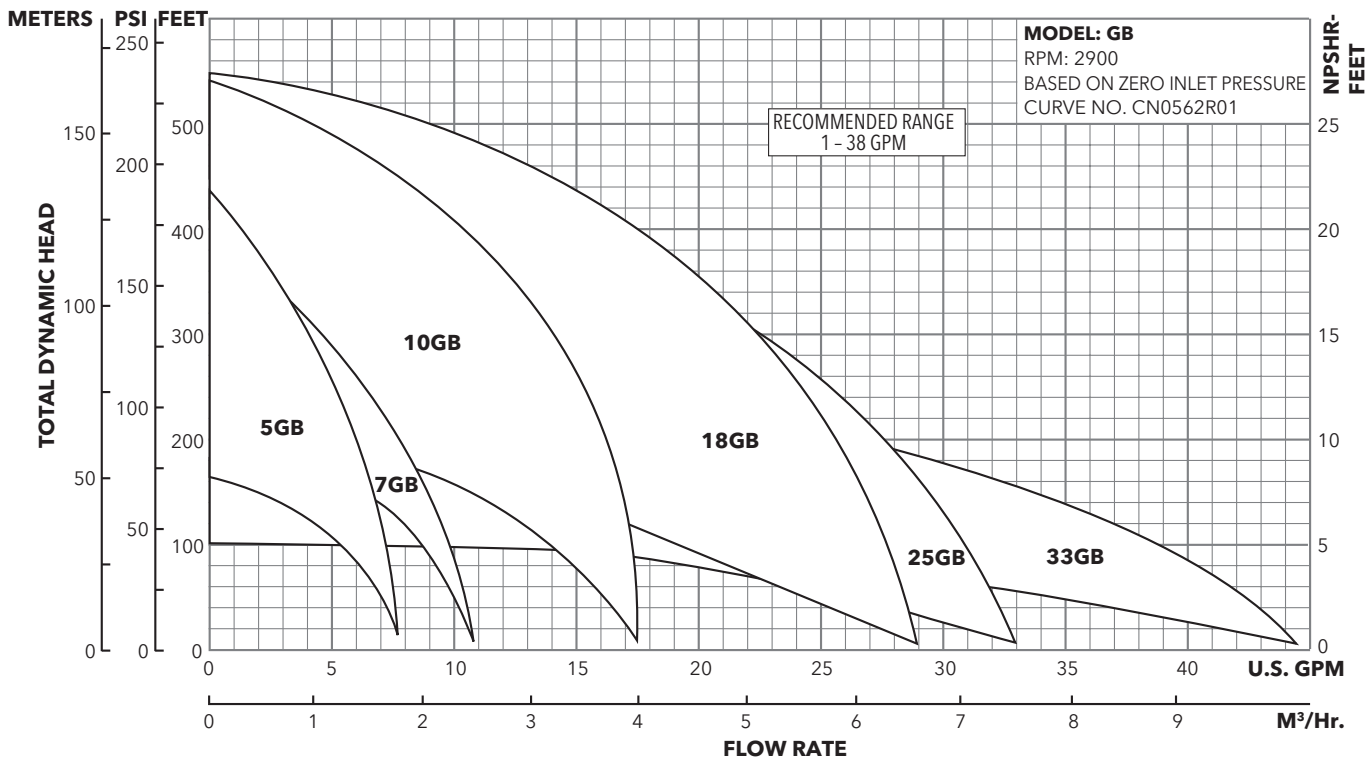

GB NUMBERING SYSTEM

The various versions of the Series GB are identified by a product code number on the pump label. This number is also the catalog number for the pump. The meaning of each digit in the product code number is shown below. The following are the standard 60 Hz product numbers and are built with Single Phase ODP motors and standard staging. The cast iron version uses Seal Code 0 and the stainless version uses Seal Code 4.

Order No.		Description					
Cast Iron	Stainless	HP	Phase	Voltage	Enclosure	Stages	
5GBC03	5GBS03	1/3 ^①	1	115-230	ODP	7	
5GBC05	5GBS05	1/2				9	
5GBC07	5GBS07	3/4				14	
5GBC10	5GBS10	1				17	
7GBC05	7GBS05	1/2				9	
7GBC07	7GBS07	3/4				13	
7GBC10	7GBS10	1				16	
10GBC07	10GBS07	3/4				8	
10GBC10	10GBS10	1				10	
10GBC15	10GBS15	1 1/2				15	
10GBC20	10GBS20	2				17	

① Unit is supplied with 1/2 HP motor.

* All 3 HP motors are 230V only.

Order No.		Description					
Cast Iron	Stainless	HP	Phase	Voltage	Enclosure	Stages	
18GBC07	18GBS07	3/4	1	115-230*	ODP	5	
18GBC10	18GBS10	1				7	
18GBC15	18GBS15	1 1/2				9	
18GBC20	18GBS20	2				13	
18GBC30	18GBS30	3				15	
25GBC07	25GBS07	3/4				5	
25GBC10	25GBS10	1				7	
25GBC15	25GBS15	1 1/2				9	
25GBC20	25GBS20	2				10	
25GBC30	25GBS30	3				14	
33GBC10	33GBS10	1				5	
33GBC15	33GBS15	1 1/2				7	
33GBC20	33GBS20	2	9				
33GBC30	33GBS30	3	13				

5GB SPECIFICATIONS

- Maximum Flow: 8 GPM
- Minimum Flow: 1 GPM
- Heads: to 600 ft. (260 PSI)
- Pipe Connections: 1" NPT Suction and Discharge

7GB SPECIFICATIONS

- Maximum Flow: 10 GPM
- Minimum Flow: 1 GPM
- Heads: to 500 ft. (216 PSI)
- Pipe Connections: 1" NPT Suction and Discharge

10GB SPECIFICATIONS

- Maximum Flow: 16 GPM
- Minimum Flow: 3 GPM
- Heads: to 560 ft. (242 PSI)
- Pipe Connections: 1" NPT Suction and Discharge

18GB SPECIFICATIONS

- Maximum Flow: 28 GPM
- Minimum Flow: 6 GPM
- Heads: to 470 ft. (203 PSI)
- Pipe Connections: 1" NPT Suction and Discharge

25GB SPECIFICATIONS

- Maximum Flow: 33 GPM
- Minimum Flow: 8 GPM
- Heads: to 430 ft. (186 PSI)
- Pipe Connections: 1" NPT Suction and Discharge

33GB SPECIFICATIONS

- Maximum Flow: 43 GPM
- Minimum Flow: 10 GPM
- Heads: to 575 ft. (249 PSI)
- Pipe Connections: 1" NPT Suction and Discharge

DIMENSIONS AND WEIGHTS FOR 60 HZ AND 50 HZ PUMPS

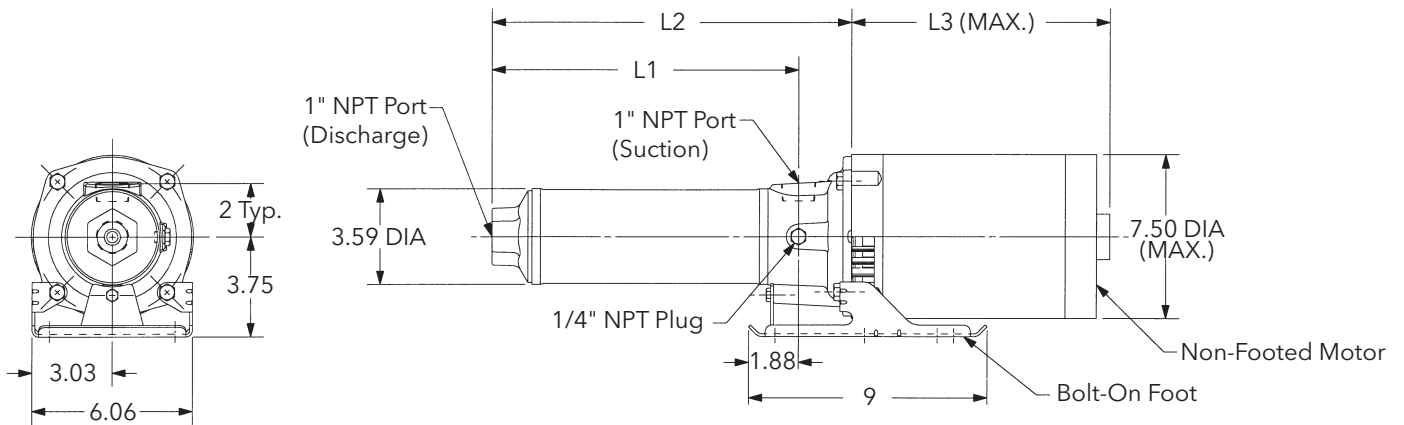
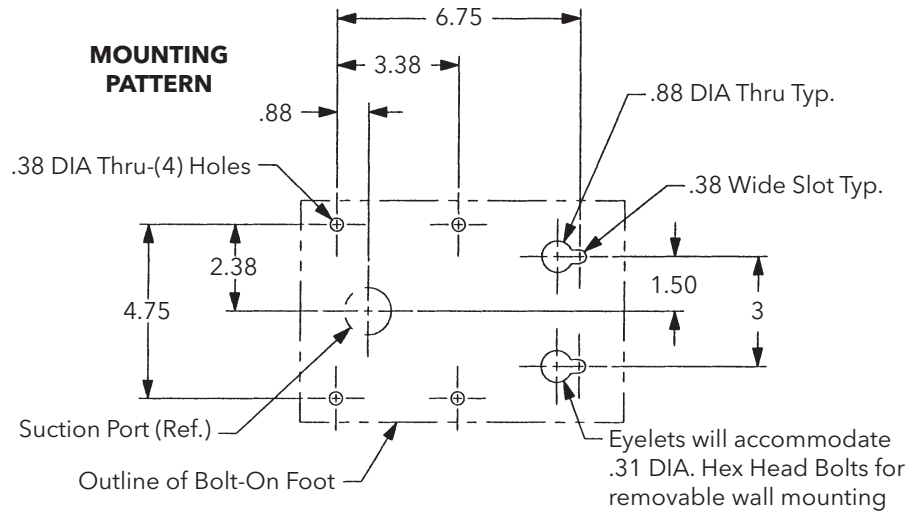

DIMENSIONS AND WEIGHTS FOR 60 HZ PUMPS

Size	Stages	L1 Approx.	L2 Approx.	HP	L3 Max.	Max. Wt. lbs.
5GB	7	9.19	11.19	1/3	10.5	41
	9	10.62	12.62	1/2	10.5	41
	14	15.12	17.12	3/4	10.62	46
	17	17.12	19.12	1	11.25	50
7GB	9	11.88	13.88	1/2	10.5	41
	13	14.44	16.44	3/4	10.62	46
	16	16.88	18.88	1	11.25	50
10GB	8	10.94	12.94	3/4	10.62	46
	10	12.31	14.31	1	11.25	50
	15	15.81	17.81	1 1/2	11.31	47
	17	17.19	19.19	2	12.06	67
18GB	5	9.69	11.69	3/4	10.62	46
	7	11.38	13.38	1	11.25	50
	9	13.12	15.12	1 1/2	11.31	47
	13	16.50	18.50	2	12.06	67
	15	18.25	20.25	3	13.03	69
25GB	5	10.12	12.12	3/4	10.62	46
	7	12.00	14.00	1	11.25	50
	9	13.88	15.88	1 1/2	11.31	47
	10	14.81	16.81	2	13.03	67
	14	18.56	20.56	3	13.03	69
33GB	5	11.77	13.77	1	11.25	51
	7	14.25	16.25	1 1/2	11.31	55
	9	16.66	18.66	2	13.03	69
	13	21.47	23.47	3	13.03	70
	19	29.03	31.03	5	14.25	78

DIMENSIONS AND WEIGHTS FOR 50 HZ PUMPS

Size	Stages	L1 Approx.	L2 Approx.	HP	L3 Max.	Max. Wt. lbs.
5GB	7	9.19	11.19	1/3	10.5	41
	10	11.31	13.31	1/2	10.5	42
	16	16.50	18.50	3/4	10.62	47
	19	18.50	20.50	1	11.25	51
7GB	10	12.60	14.60	1/2	10.5	42
	15	15.87	17.87	3/4	10.62	47
	18	18.31	20.31	1	11.25	51
10GB	9	11.63	13.63	3/4	10.62	47
	11	13.00	15.00	1	11.25	51
	17	17.19	19.19	1 1/2	11.31	48
	23	21.32	23.32	2	12.06	68
18GB	8	12.23	14.23	1	11.25	51
	12	15.68	17.68	1 1/2	11.31	48
	16	19.06	21.06	2	12.06	68
	23	25.07	27.07	3	13.03	70
25GB	5	10.12	12.12	3/4	10.62	46
	7	12.00	14.00	1	11.25	50
	10	14.82	16.82	1 1/2	11.31	48
	14	18.56	20.56	2	13.03	68
	21	25.13	27.13	3	13.03	70
33GB	6	13.00	15.00	1	11.25	52
	10	17.88	19.88	2	13.03	70
	14	22.69	24.69	3	13.03	71

5GB PERFORMANCE CURVES

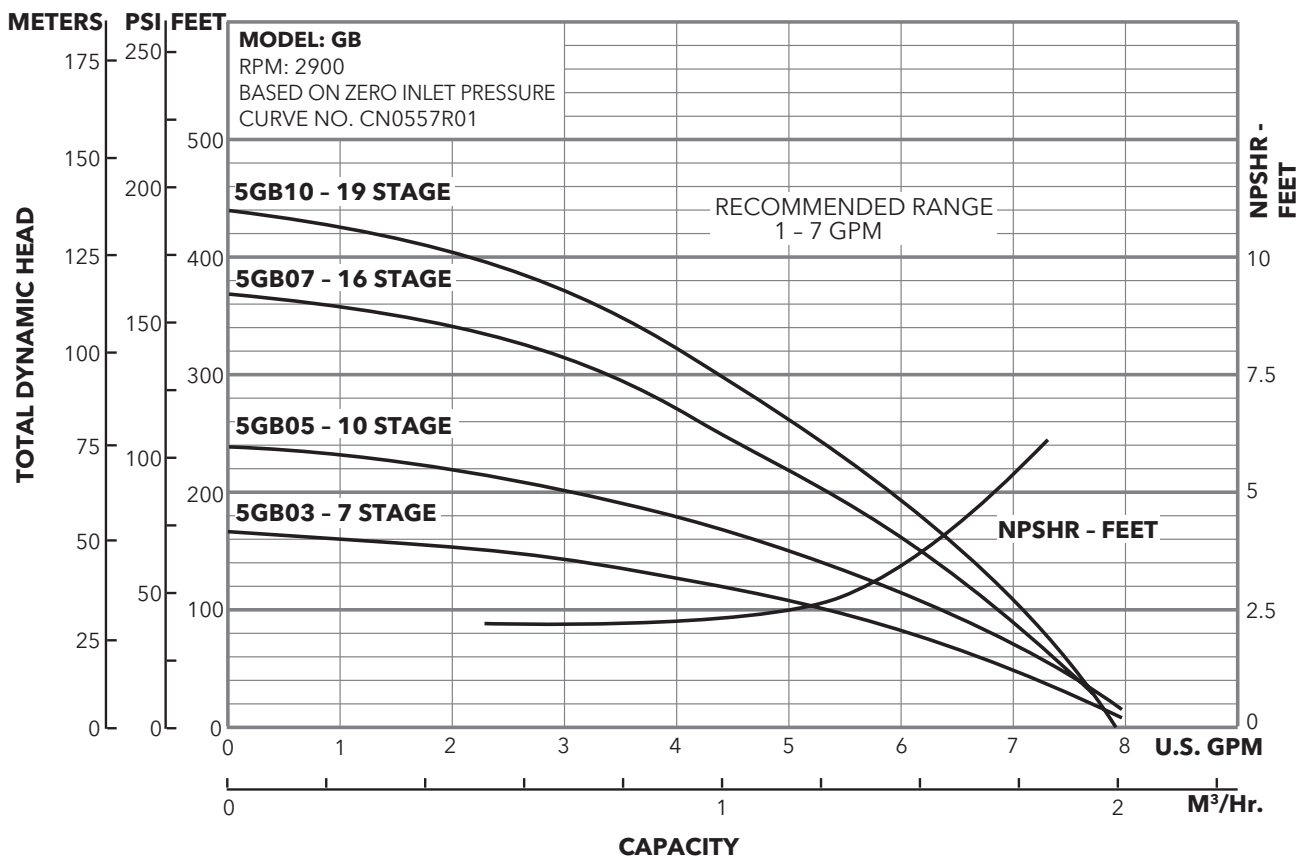
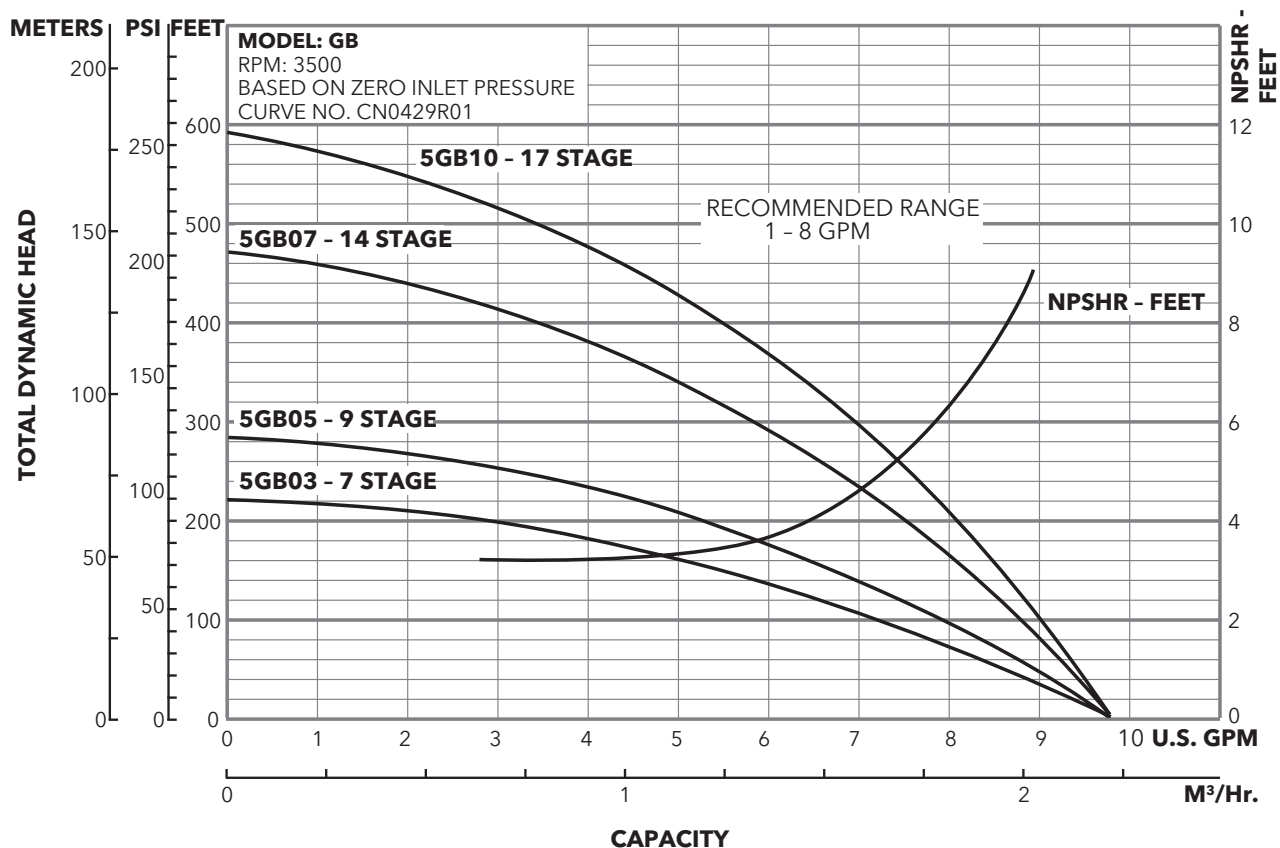

7GB PERFORMANCE CURVES

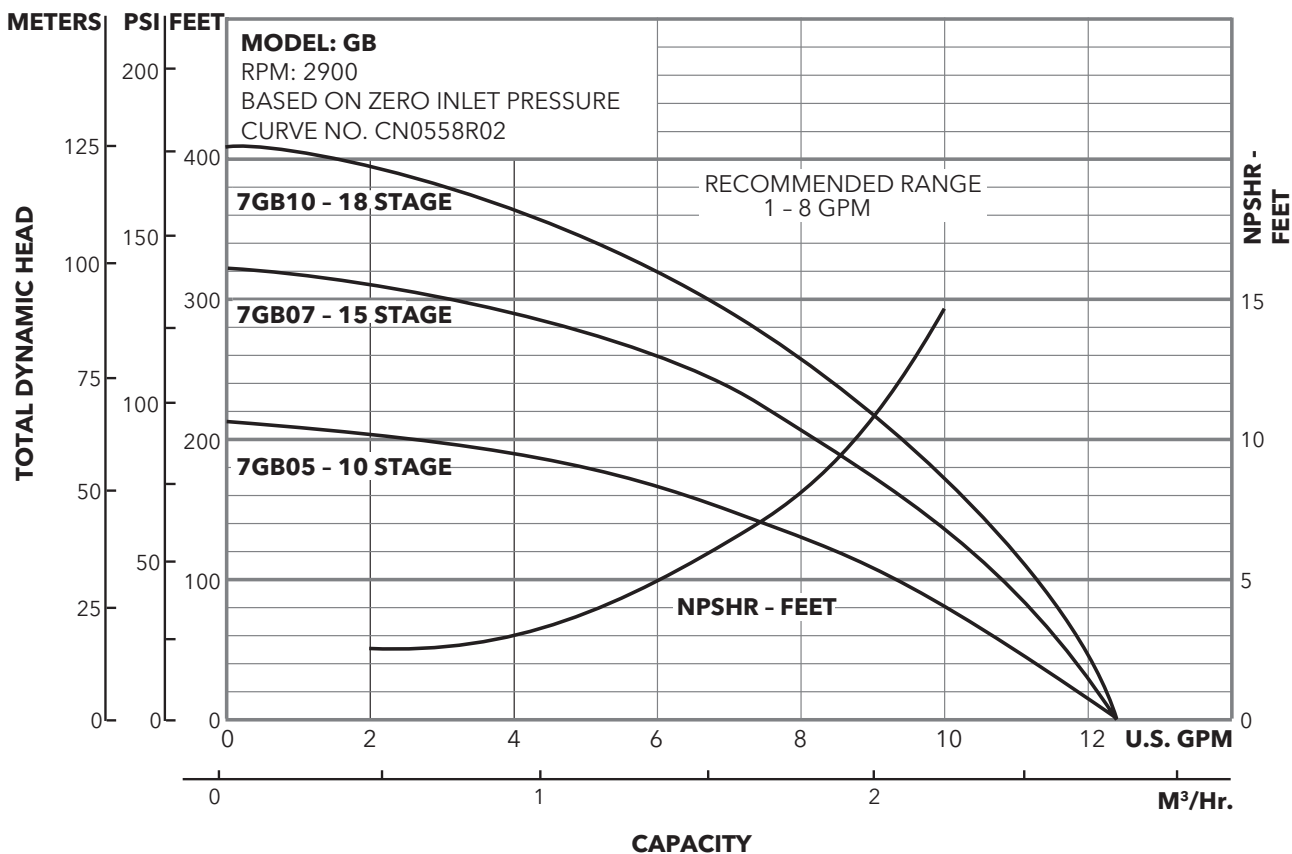
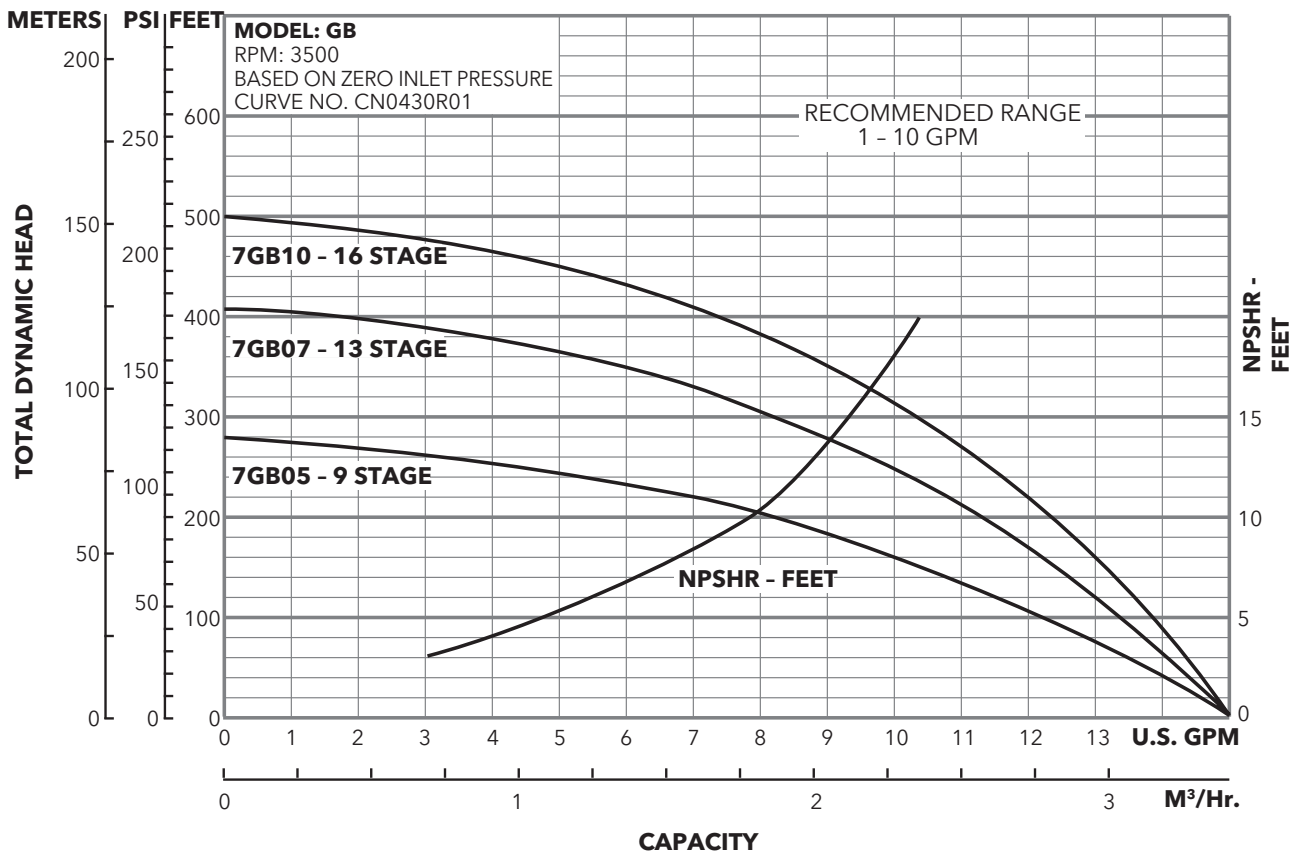

10GB PERFORMANCE CURVES

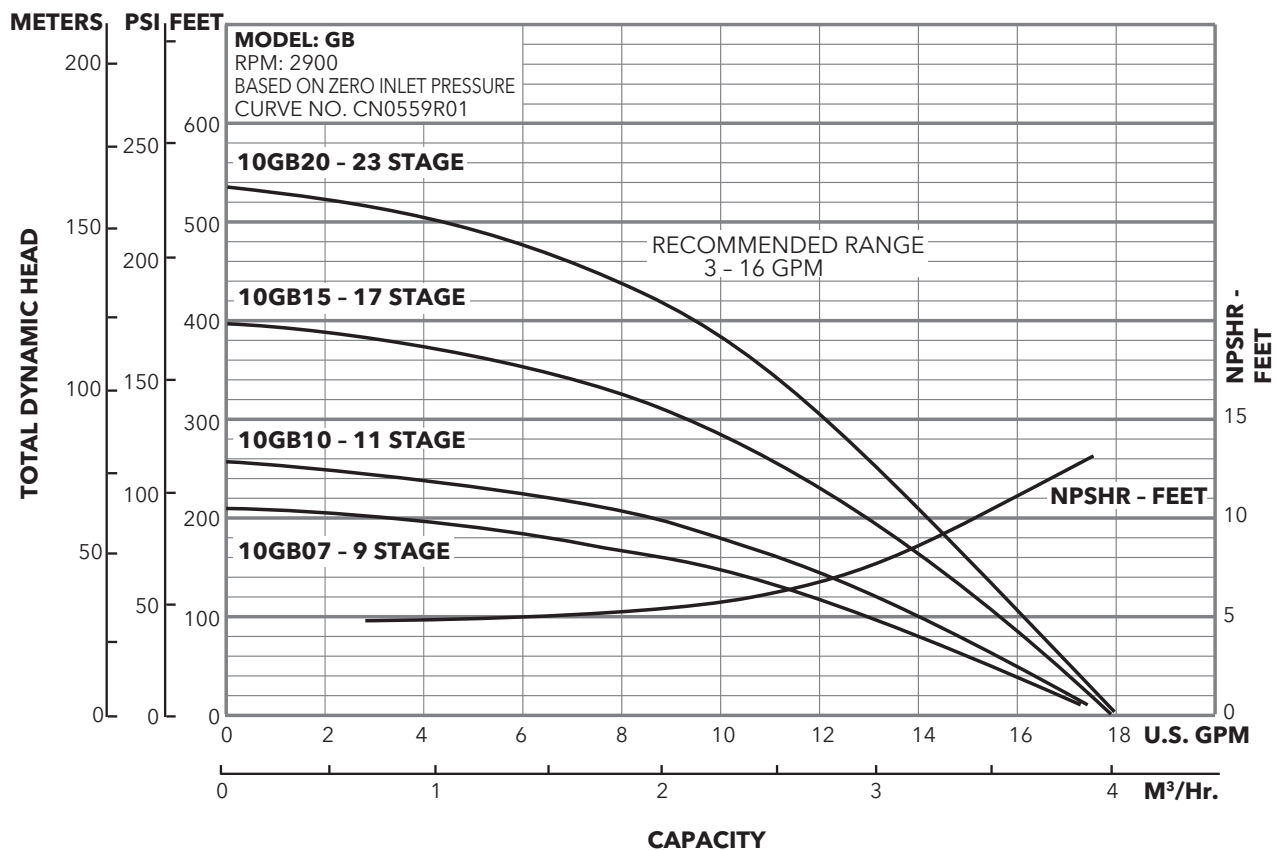
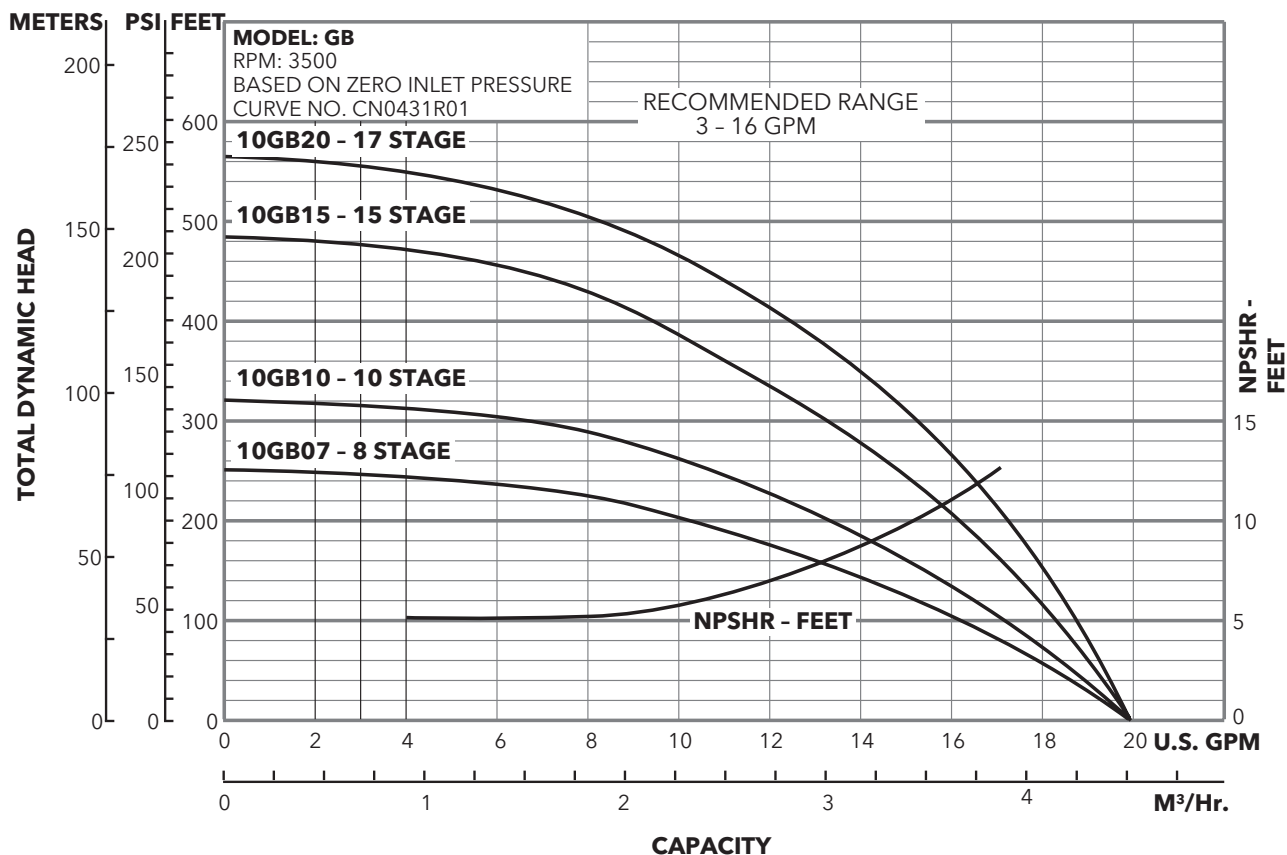

18GB PERFORMANCE CURVES

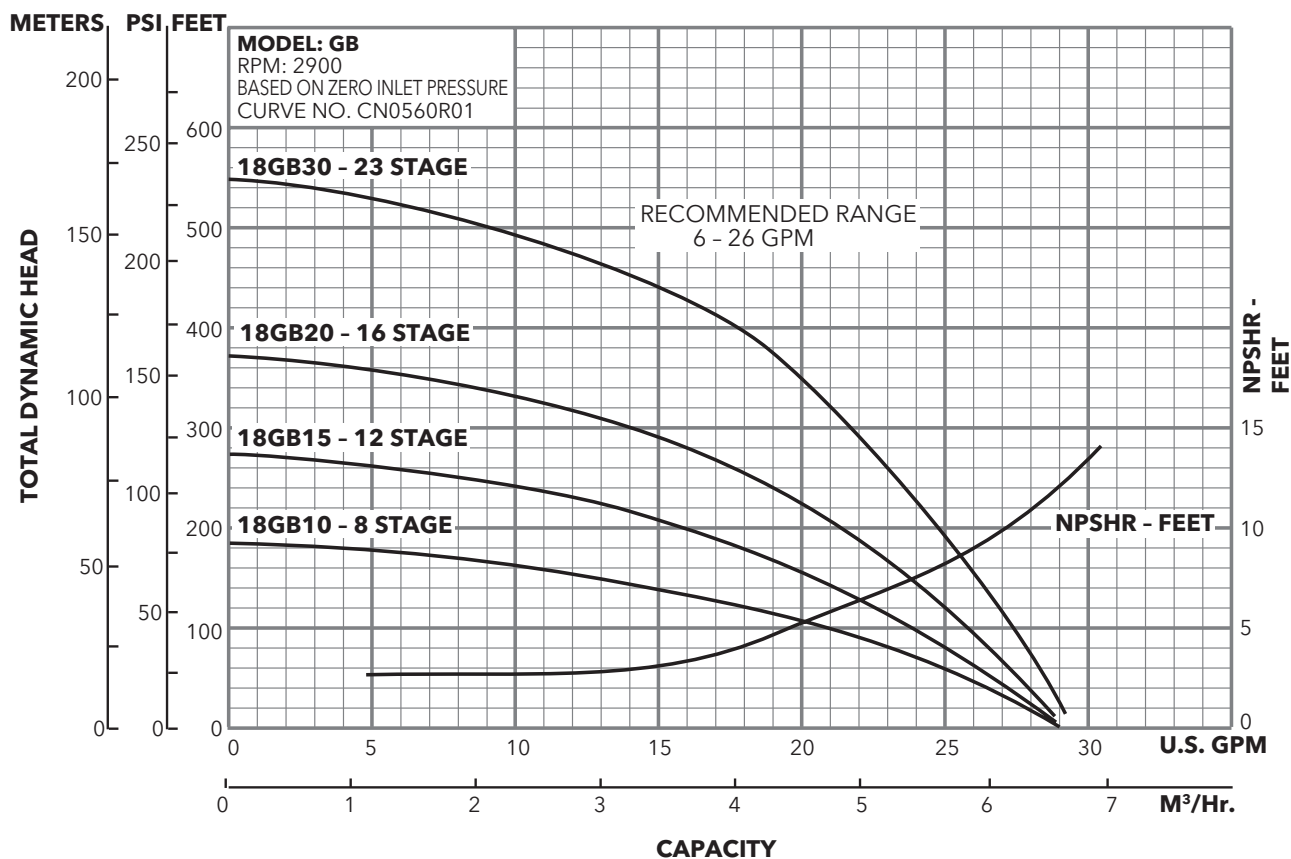
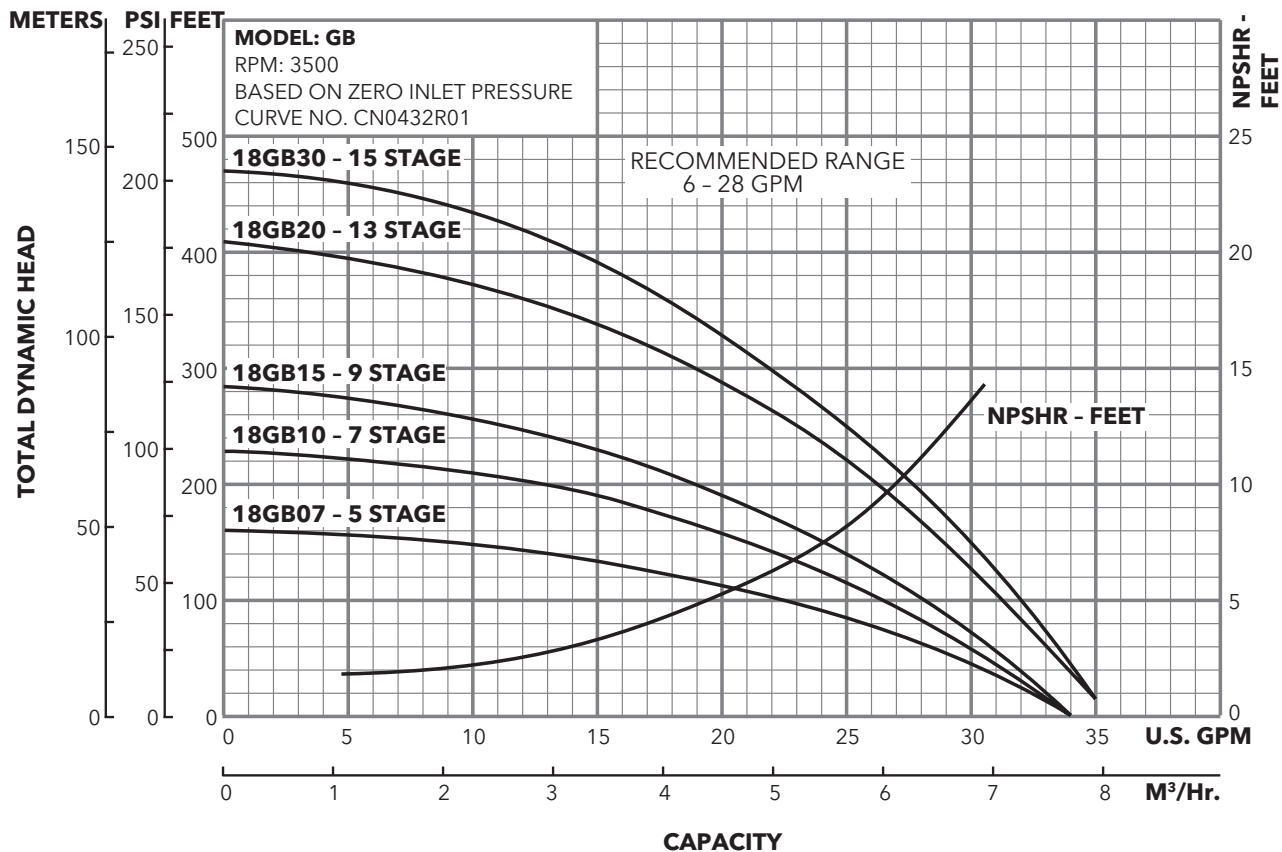

25GB PERFORMANCE CURVES

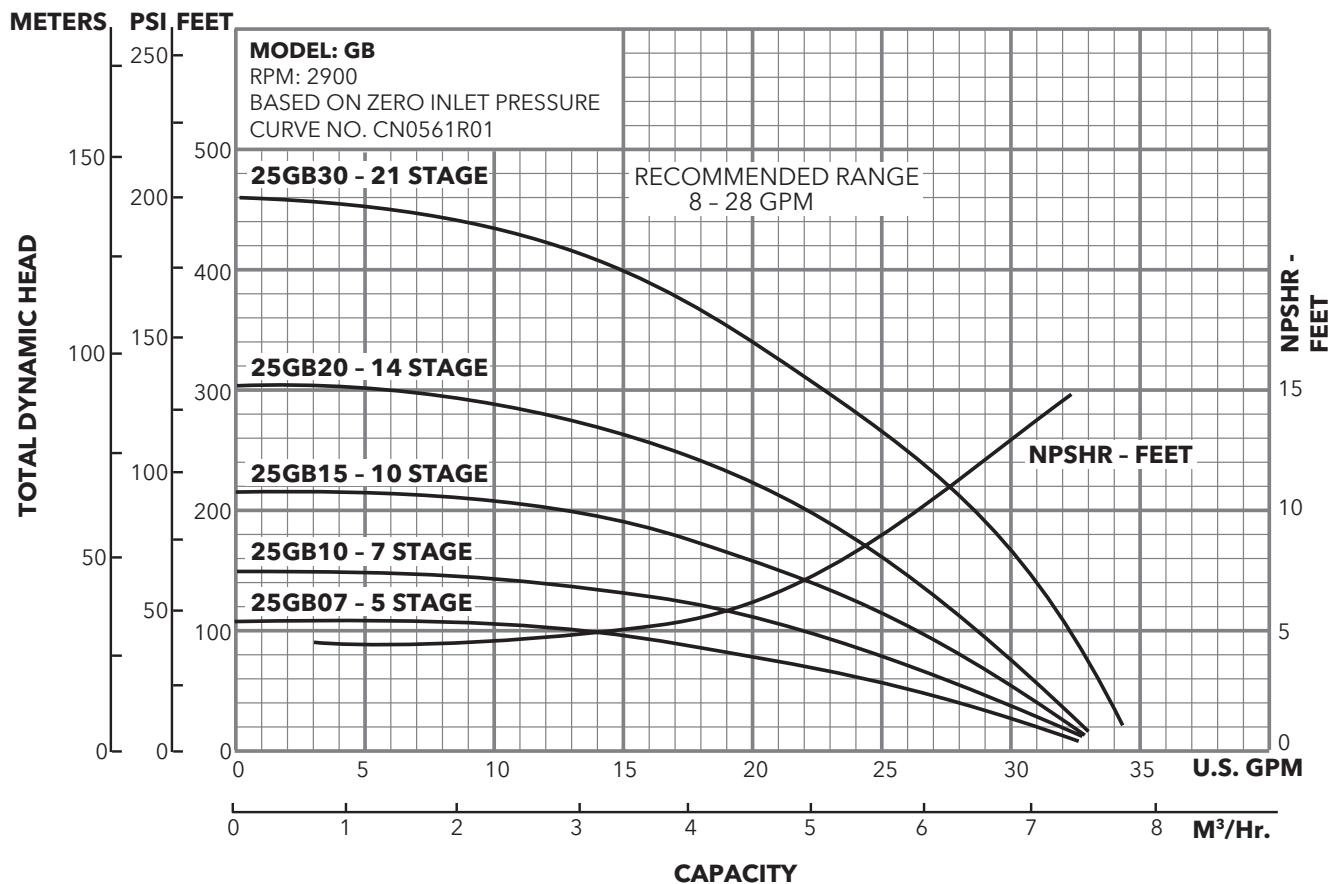
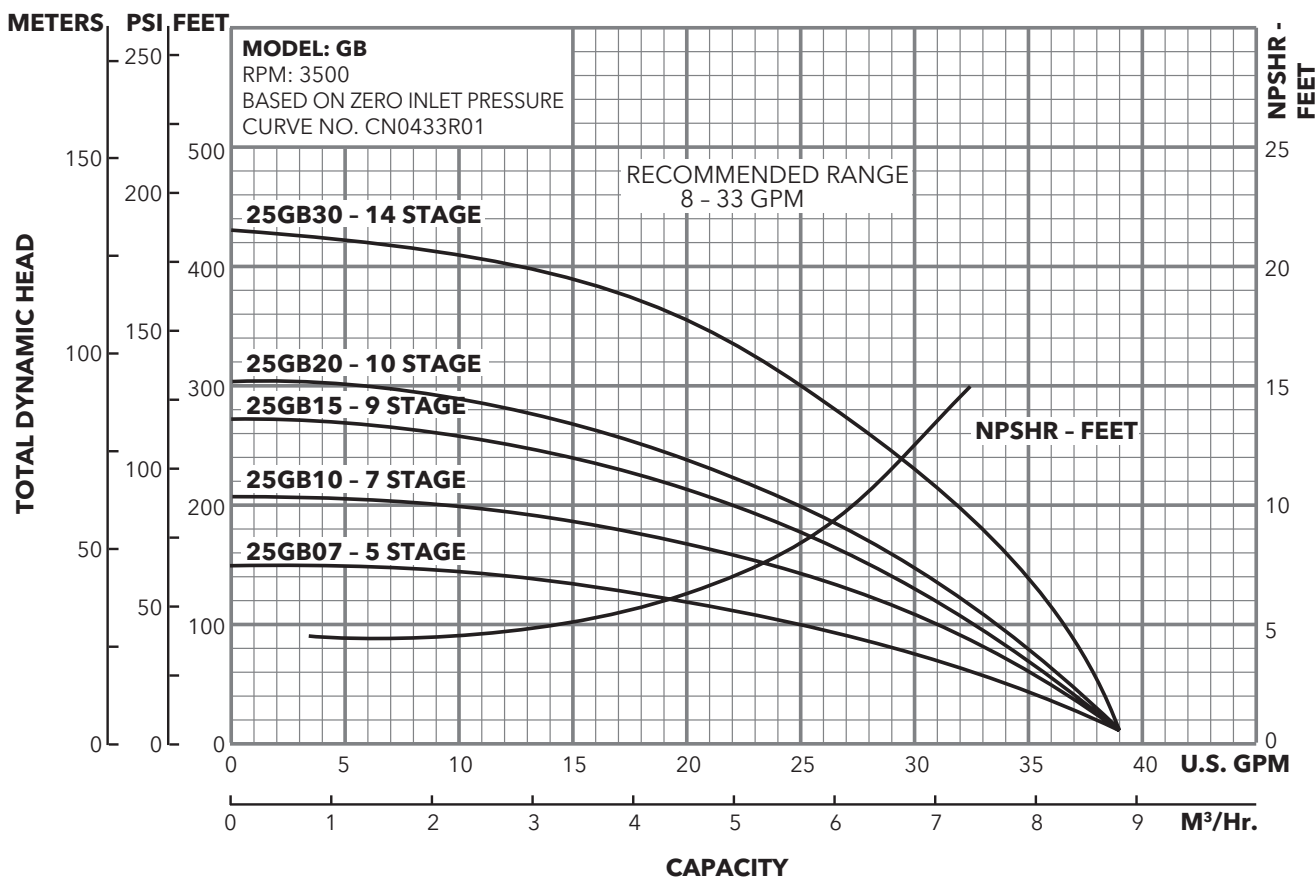

33GB PERFORMANCE CURVES

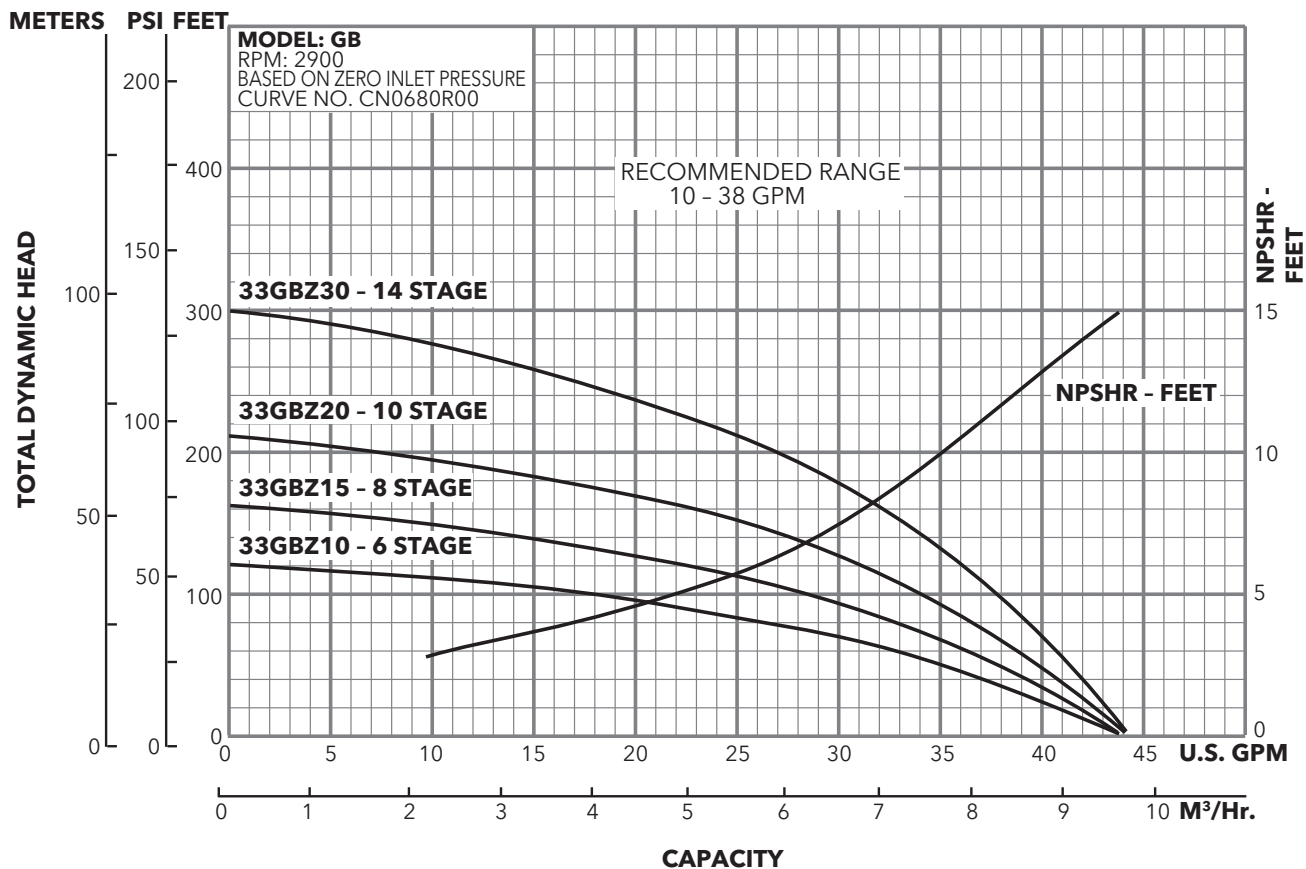
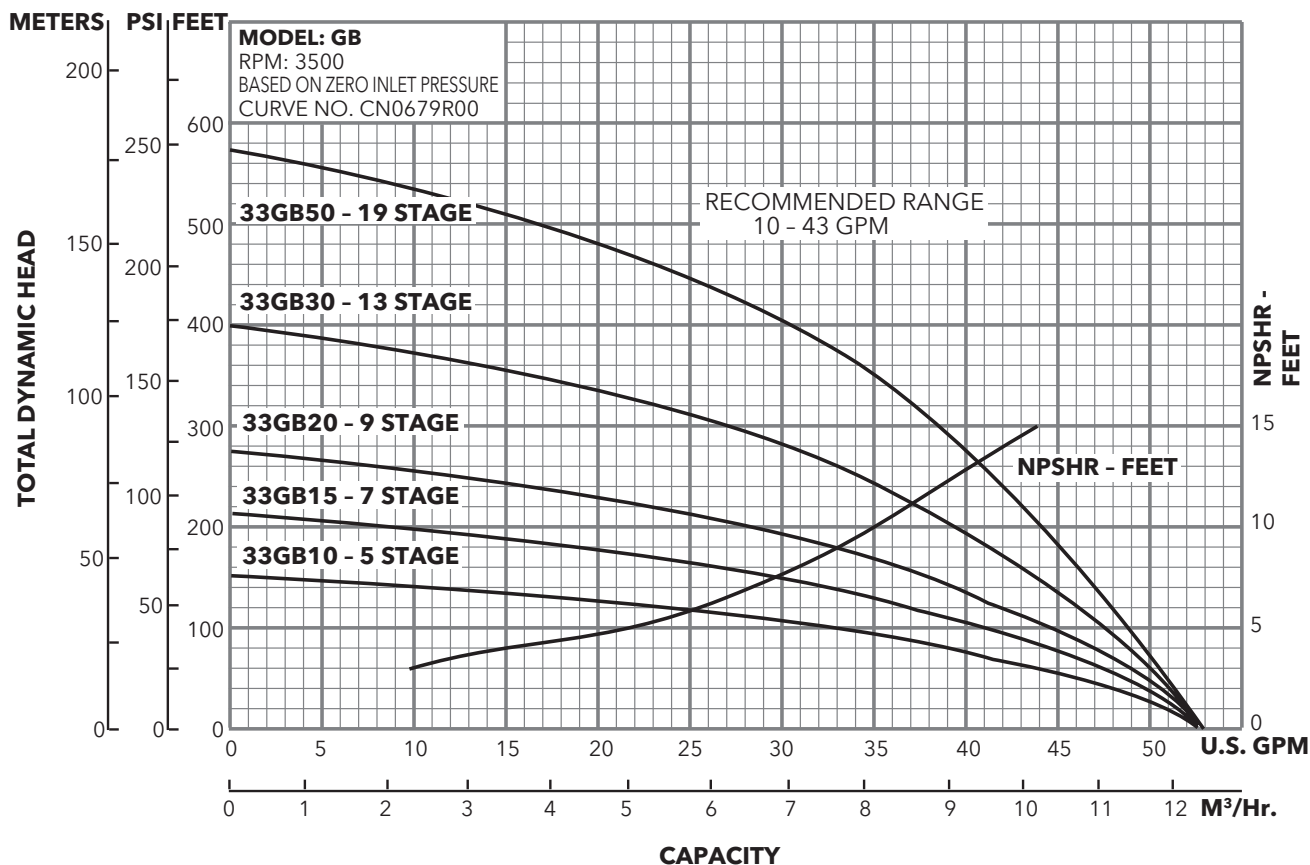

ACCESSORIES

HOSE



AM3-5 - Discharge Hose
3/4" male x 3/4" female, 250 PSI
hose, 40 ft. section, flexible.

AM4 - Suction Hose
3/4" female x 3/4" female, 150 PSI
hose, 4 ft. section flexible.

HANDLE



4K452
Formed carbon steel
handle is standard on 7GB
WaterGun® and can be
ordered separately for use
on other sizes.

PRESSURE GUN



AM2-2
Designed for use with
WaterGun®. Nozzle passes
approximately 5.7 GPM
at 140 lbs. pressure and
provides a most effective
angle spray.

PIPE ADAPTER



AM5-1
3/4" male HT x 1" male NPT
hose to pipe adapter,
stainless steel. Converts
suction and discharge to
3/4" male NPT hose.

NOTES

Xylem |'zīləm|

- 1) The tissue in plants that brings water upward from the roots;
- 2) a leading global water technology company.

We're a global team unified in a common purpose: creating innovative solutions to meet our world's water needs. Developing new technologies that will improve the way water is used, conserved, and re-used in the future is central to our work. We move, treat, analyze, and return water to the environment, and we help people use water efficiently, in their homes, buildings, factories and farms. In more than 150 countries, we have strong, long-standing relationships with customers who know us for our powerful combination of leading product brands and applications expertise, backed by a legacy of innovation.

For more information on how Xylem can help you, go to www.xylem.com



Xylem Inc.
2881 East Bayard Street Ext., Suite A
Seneca Falls, NY 13148
Phone: (866) 325-4210
Fax: (888) 322-5877
www.gouldswatertechnology.com

Goulds is a registered trademark of Goulds Pumps, Inc.
and is used under license.

© 2015 Xylem Inc. B5-33GB R1 October 2015